

GRReddy®

***GR*Reddy Intercooler Kit**

Nissan 300ZX Twin Turbo (VG30DETT)



Nissan 300ZX Twin Turbo (Z32)

Installation Manual

Please read the entire manual before installing this kit.

Application:

Make	Model	Chassis	Year
Nissan	300ZX	Z32	89 ~ 97

- This **Greddy Intercooler Kit** is designed only for the vehicles specified above with a VG30DETT engine.

Nissan 300ZX Twin Turbo
(VG30DETT)
Intercooler Kit

1. Parts List

	Qty
1. Intercooler (R)	1
Intercooler (L)	1
2. Bracket for intercooler (R)	1
Bracket for intercooler (L)	1
3. Intake tube-straight-50mm dia. x 70mm (alum)	2
4. Rubber hose-straight-50mm dia. x 70mm	4
5. Hose clamps-50mm dia. clamp size #32	8
6. 8mm x 25mm 1.25 pitch stainless steel, lock washer, flat washer, nuts	2
7. 8mm x 15mm 1.25 pitch stainless steel, lock washer, flat washer, nuts	8

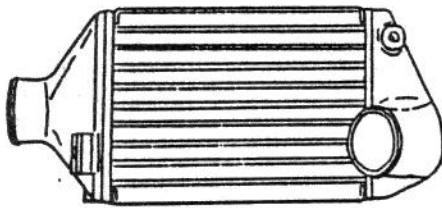

1 R

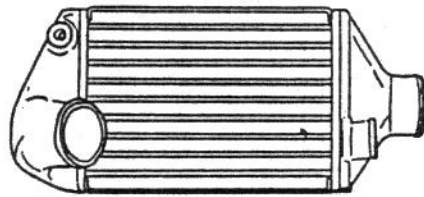

1 L

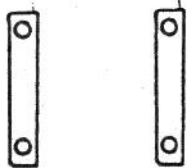

2 R

2 L

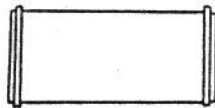

3



4



5

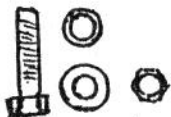

6













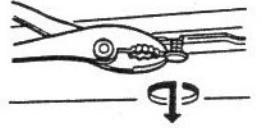
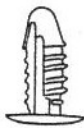

7

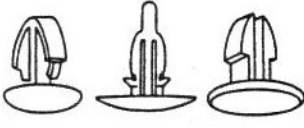
* Operation and description of body clips used on the 300ZX Twin Turbo.

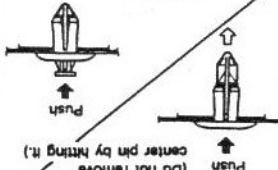
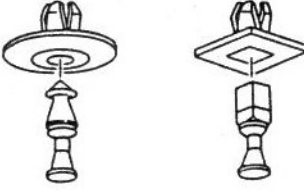
Clip and Fastener

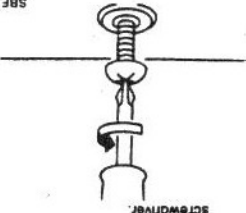
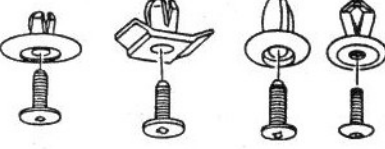
- Clips and fasteners in Bf section correspond to the following numbers and symbols.
- Replace any clips and/or fasteners which are damaged during removal or installation.

Removal & Installation	Shapes	Symbol No.
<p>Removal: Remove by bending up with flat-bladed screwdrivers.</p> 	<p>SBF256G</p> 	 <p>C101</p>
<p>Removal: Pull up by rotating.</p> 	<p>SBF137B</p>  <p>SBF114B</p> 	 <p>C102</p>
<p>Removal: Remove with a flat-bladed screwdriver or pliers.</p> 	<p>SBF292C</p> 	 <p>C103</p>
<p>Installation: Push center pin to catching position. (Do not remove center pin by hitting it.)</p> 	<p>SBF259C</p> 	 <p>C203</p>
<p>Removal: Screw out with a Phillips screwdriver.</p> 	<p>SBF260G</p> 	 <p>CS101</p>

2. Removal of stock parts

- 2-1. Remove front bumper skin, under guards, and intercooler ducts.
- 2-2. Left side - remove inner fender, coolant reservoir tank and purge canister.
- 2-3. Right side - remove inner fender
- 2-4. Left and right side - mark direction of charge hoses that fit to intercooler, and remove hoses.

Body Front End

Hood lock adjustment

- Adjust lock so that hood primary lock meshes at a position where hood is 1 to 1.5 mm (0.039 to 0.059 in) lower than fender.
- After hood lock adjustment, adjust bumper rubber.
- When securing hood lock, ensure it does not tilt. Striker must be positioned at the center of hood primary lock.
- After adjustment, ensure that hood primary and secondary lock operate properly.

Hood lock secondary latch hooking length

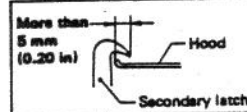

Bumper rubber adjustment

- Adjust so that hood is aligned with fender. [Bumper rubber free height is approx. 15 mm (0.59 in).]

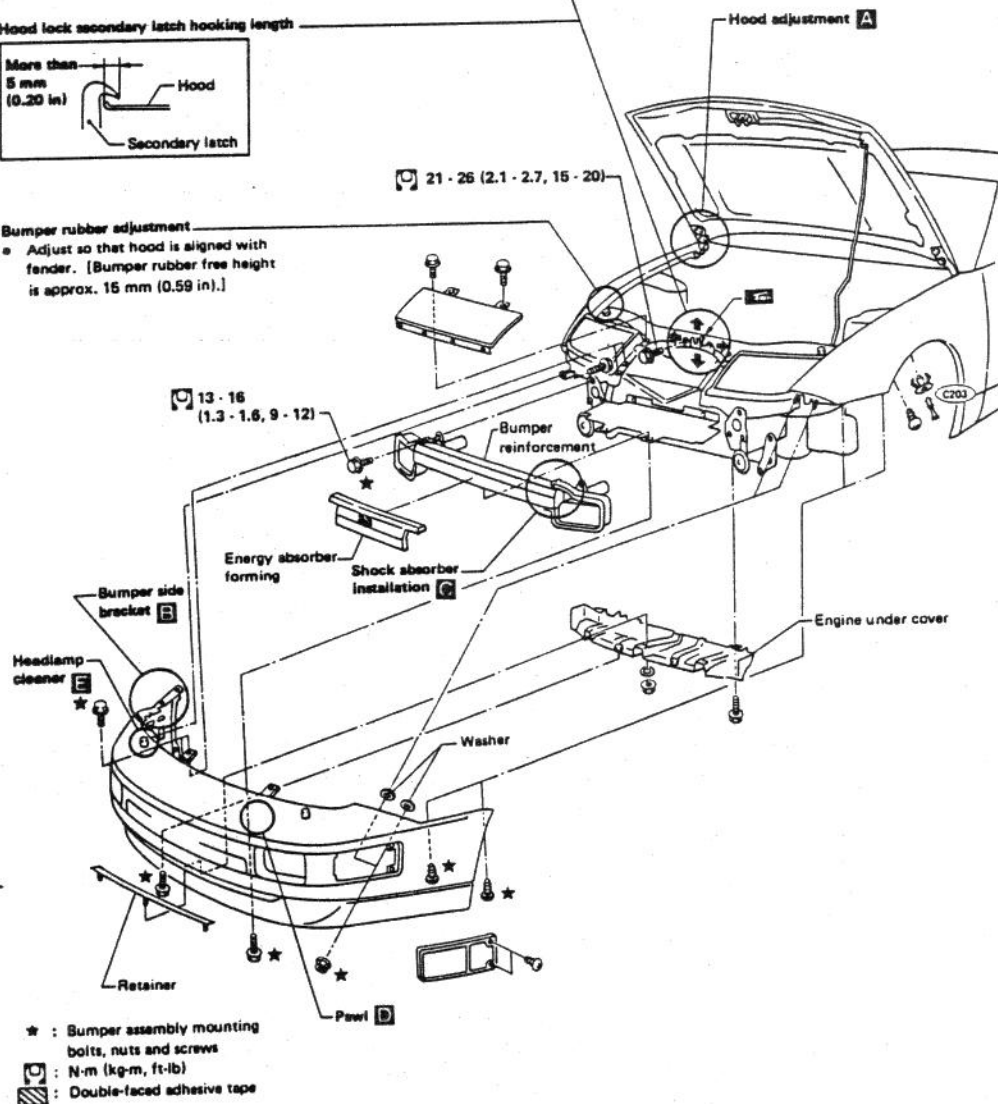

- ★ : Bumper assembly mounting bolts, nuts and screws
- ▣ : N-m (kg-m, ft-lb)
- ▨ : Double-faced adhesive tape

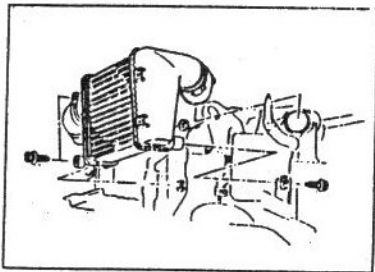
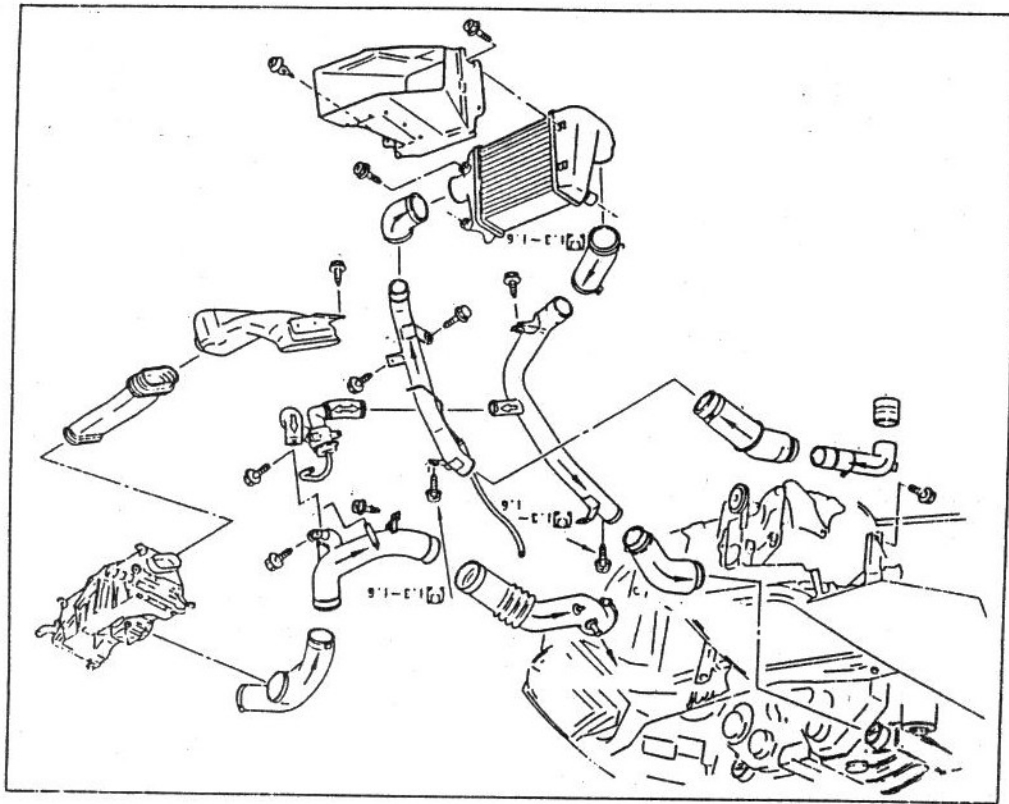

* Intercooler pipe routing and intercooler mounting location. (right side)

- 3.1 Right side - remove OEM intercooler right side
- 3.2 Right side - install Greddy intercooler
 - * Take great care not to damage core of intercooler - core is all aluminum, which is very easily damaged.

4.1 Left side - remove OEM intercooler

4.2 Left side - install Greddy intercooler

* Take great care not to damage intercooler core - intercooler core is all aluminum, which is very easily damaged.

* Intercooler pipe routing and intercooler mounting location. (left side)

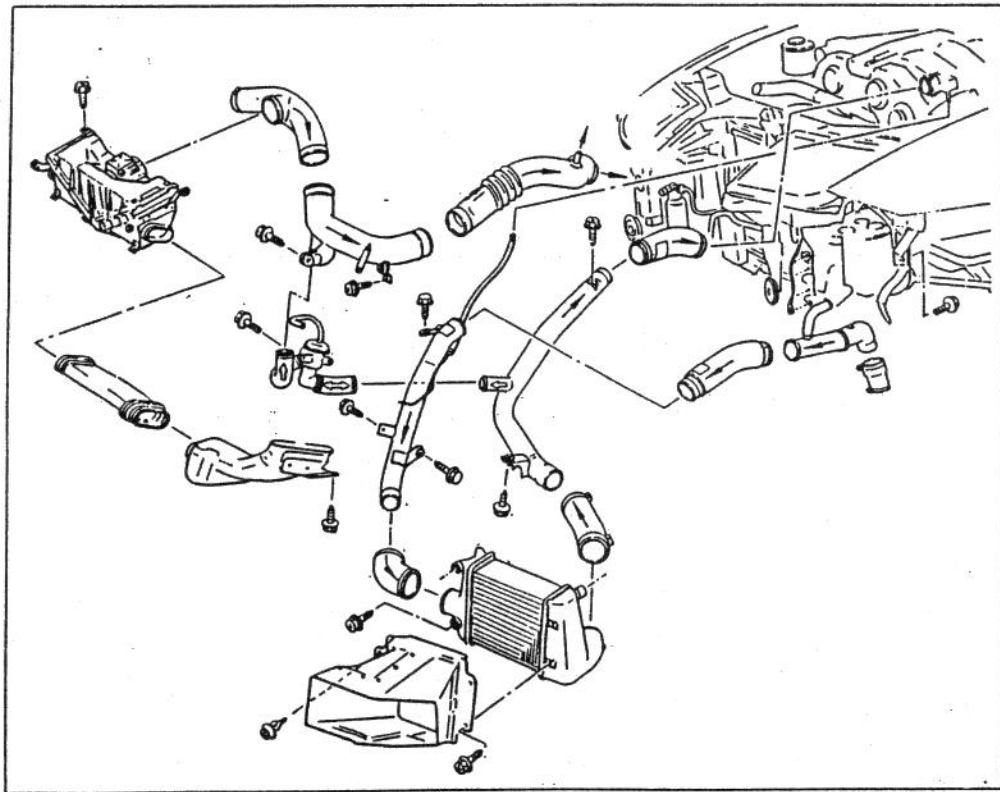
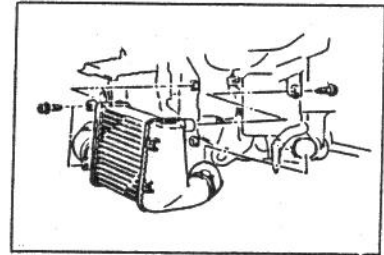

5. Modifying OEM intercooler related parts
(Right side and left side)

5.1 Modify intercooler air ducts as shown in picture below.

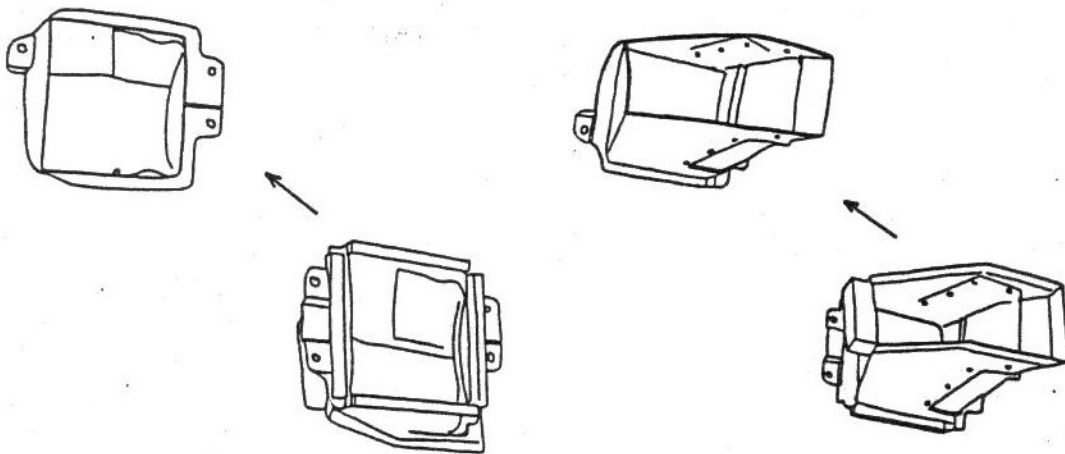

5.2 Right side and left side.
Modifying rubber hose remove 20mm from rubber hose that is
fit to the inlet of the intercooler

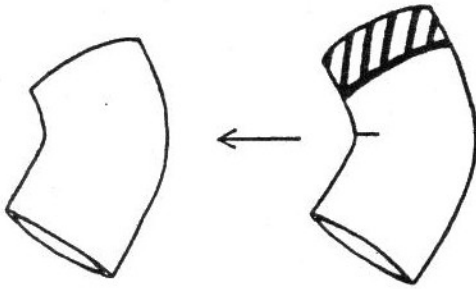

6. Fitting both left and right intercoolers

6.1 Left side - right side

Remove lower bolt from tow hook

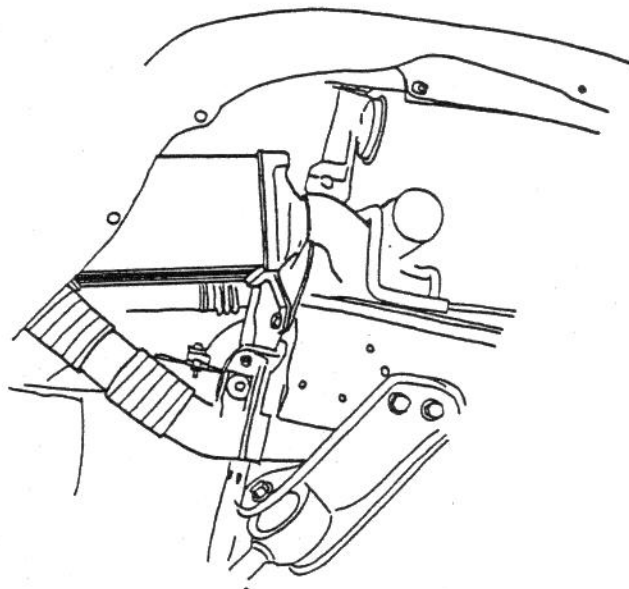
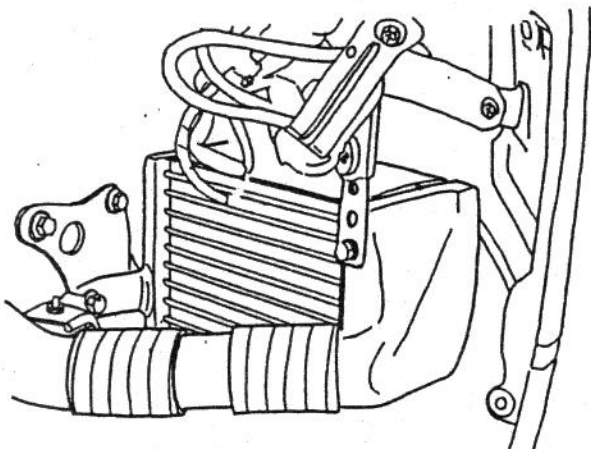

6.2 Left side - right side

Fit intercooler into place using lower tow hook hole for intercooler mounting bracket

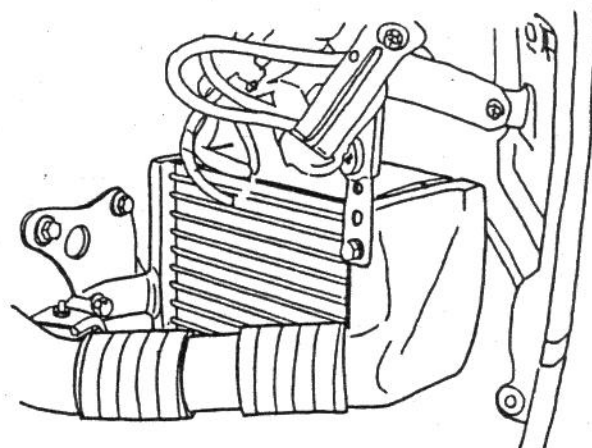
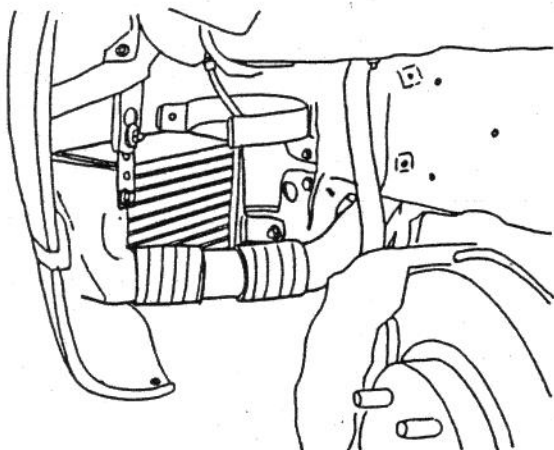

6.3 Left - right side

Use supplied bracket to mount opposite side of intercooler to bumper bracket

(see photo)

above

6.4 Left side - right side outlet
Use supplied 50 mm dia. Aluminum adapter, hose and clamps
on outlet side of intercooler

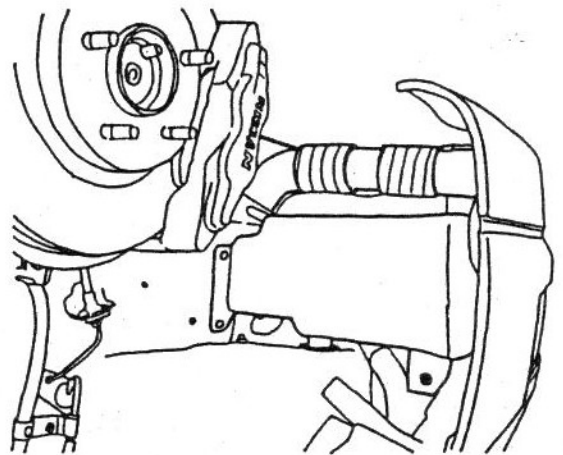

6.5 Left side - right side
use modified rubber hose, on inlet side of intercooler

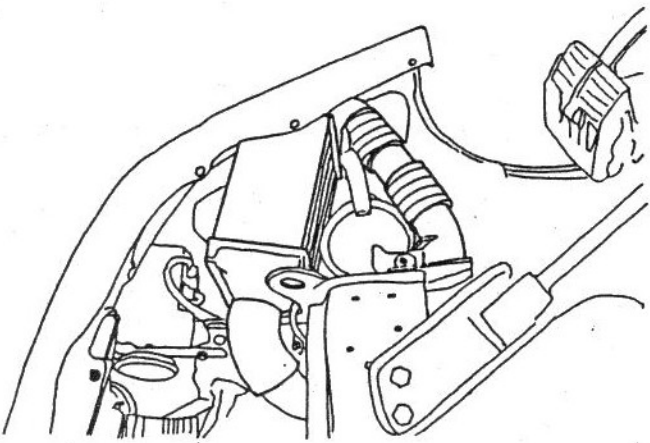

* Caution - Do not tighten clamps on intercooler hoses until
intercooler is fit into its final position.

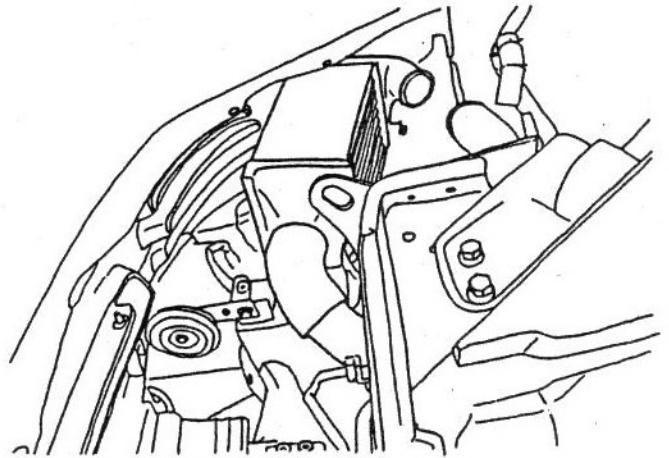

6.6 Left side only

Charcoal canister must be rotated to clear intercooler

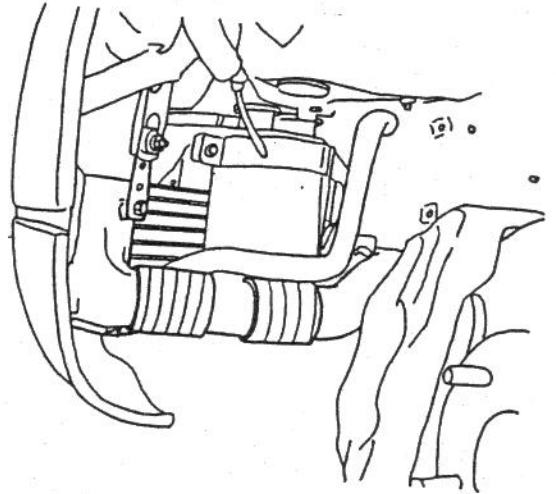
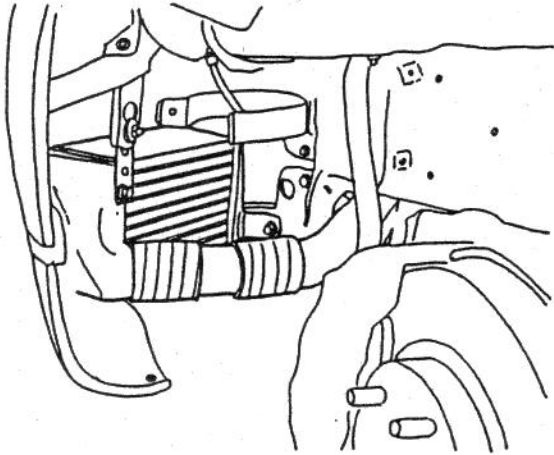

* **Caution:** Do not kink or crack any of the vapor or vacuum lines going to charcoal canister

7. Start up and reassemble

7.1 Start engine allow to idle

Check for any unusual noises

Check for vacuum leaks

Shut off engine after check

7.2 Reassemble front bumper and under cover

7.3 Left and right side - re-install inner fender

* **Caution:** In case inner fender come in contact with intercooler, modify by cutting the inner fender to fit.

7.4 Start engine allow to warm up checking one final time for noises or vacuum leaks.

7.5 Check manifold pressure. (Boost)

Congratulations - Installation is Completed